

Datasheet

Touch Pure Tree

Part No: 100461, 100462



About the product

The Loxone Touch Pure Tree features five touch points on a glass surface to control the most important functions of a room. When a button is touched, an acoustic click confirms the action. An integrated sensor measures temperature and relative humidity. An orientation light makes it possible to locate the device in the dark.

Electrical Data

Power supply	6 ... 30VDC
Power consumption	typ. 49mW, max. 95mW
Power loss	max. 95mW
Interfaces	Loxone Tree: connection with Miniserver / Tree Extension
Ambient temperature	-20 ... 70°C / -4 ... 158°F
Humidity	max. 95% r.H. (non condensing)
Touch points	5 touch points, capacitive touch detection
Click feedback	Yes
Temperature detection range	-40 ... 125°C / -40 ... 257°F; +/- 0.5°C / 0.9°F
Humidity detection range	0 ... 100% r. H. +/- 2%, (non condensing)
Orientation light	Yes

Connections

Wire cross-section	0.25 ... 0.8mm ² / AWG23 ... 18
Stripping length	5mm / 0.2"
Temperature resistance	-40 ... 105°C / -40 ... 221°F
Orange / White	+ 24VDC / GND
Green / White	Loxone Tree

Connection Diagram

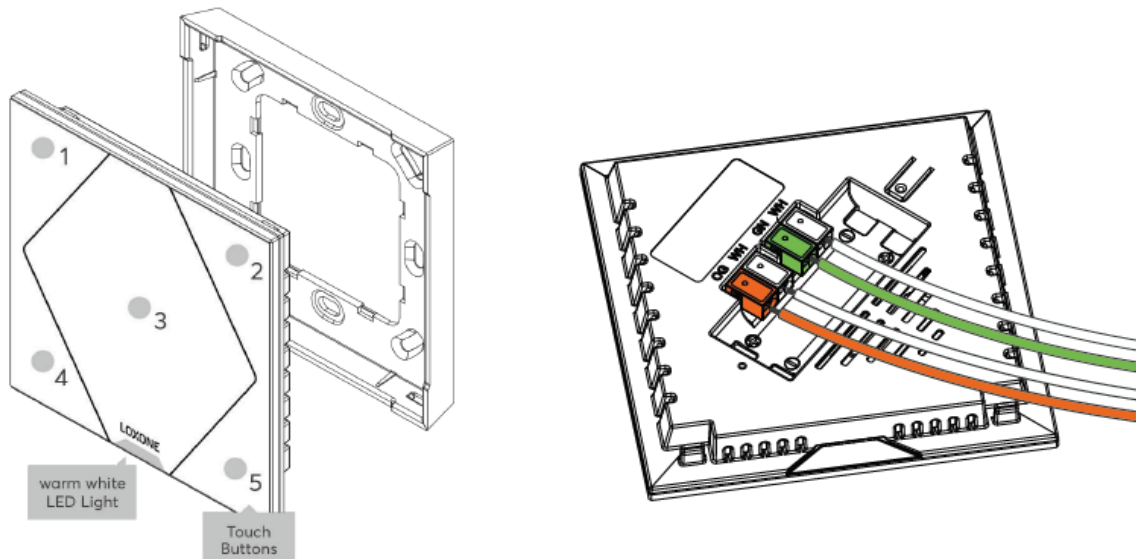

Product Characteristics

Colours	Anthracite: RAL7016 - Part No. 100462 White: RAL9003 - Part No. 100461
Finish	Matte

Weight & Dimensions

Net weight	110g
Total weight	136g
Product dimensions	90x90x16mm / 3.55x3.55x0.63" (LxWxH)

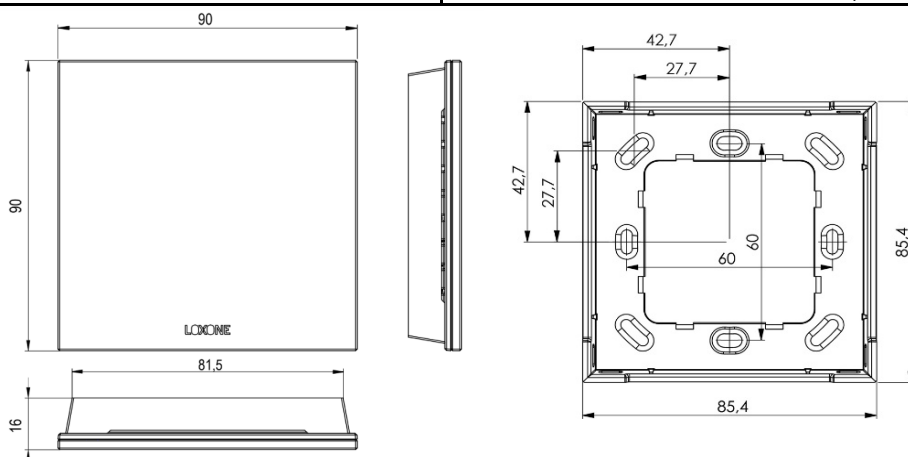

Pack size	104x107x39mm / 4.09x4.21x1.54" (LxWxH)
-----------	--

Certifications & Standards

Safety rating

IP30

Certifications

UL 62368-1
CSA C22.2#62368-1

RECOGNIZED
COMPONENT



Installation must be carried out by a qualified electrician in accordance with the relevant regulations.

Published by
Loxone Electronics GmbH
Smart Home 1
4154 Kollerschlag
Austria
Tel: +43 7287 7070-0
loxone.com

Datenblatt

Touch Pure Tree

Art. Nr. 100461, 100462



Information zum Produkt

Der Loxone Touch Pure Tree verfügt über fünf Tastpunkte auf einer Glasfront, zur Bedienung der wichtigsten Funktionen eines Raumes. Bei Berührung einer Taste erfolgt ein Klicken als akustische Bestätigung. Zur Messung von Temperatur und relativer Luftfeuchte ist ein Sensor integriert. Ein Orientierungslicht ermöglicht das Erkennen des Gerätes im Dunkeln.

Elektrische Daten

Spannungsversorgung	6 ... 30VDC
Leistungsaufnahme	typ. 49mW, max. 95mW
Leistungsverlust	max. 95mW
Schnittstellen	Loxone Tree: Verbindung mit Miniserver / Tree Extension
Umgebungstemperatur	-20 ... 70°C / -4 ... 158°F
Luftfeuchtigkeit	max. 95% r.H. (nicht kondensierend)
Tastpunkte	5 Tastpunkte, kapazitive Berührungserkennung
Klick Feedback	Ja
Messbereich Temperatursensor	-40 ... 125°C / -40 ... 257°F; +/- 0,5°C / 0,9°F
Messbereich Luftfeuchtigkeitssensor	0 ... 100% r. H. +/- 2%, (nicht kondensierend)
Orientierungslicht	Ja

Anschlüsse

Leiterquerschnitt	0,25 ... 0,8mm ² / AWG23 ... 18
Abisolierlänge	5mm / 0,2"
Temperaturbeständigkeit	-40 ... 105°C / -40 ... 221°F
Orange / Weiß	+ 24VDC / GND
Grün / Weiß	Loxone Tree

Anschlussplan

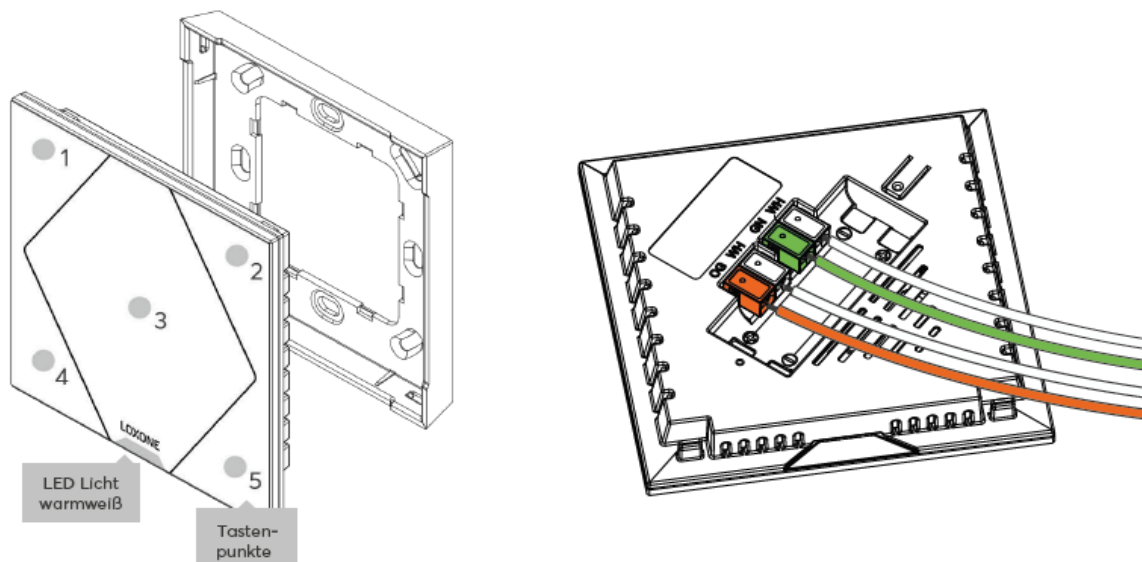

Produkteigenschaften

Farbe	Anthrazit: RAL7016 - Art. Nr. 100462 Weiß: RAL9003 - Art. Nr. 100461
Glanzgrad	Matt

Gewicht & Abmessungen

Nettogewicht	110g
Bruttogewicht	136g
Produktmaße	90x90x16mm / 3,55x3,55x0,63" (LxBxH)

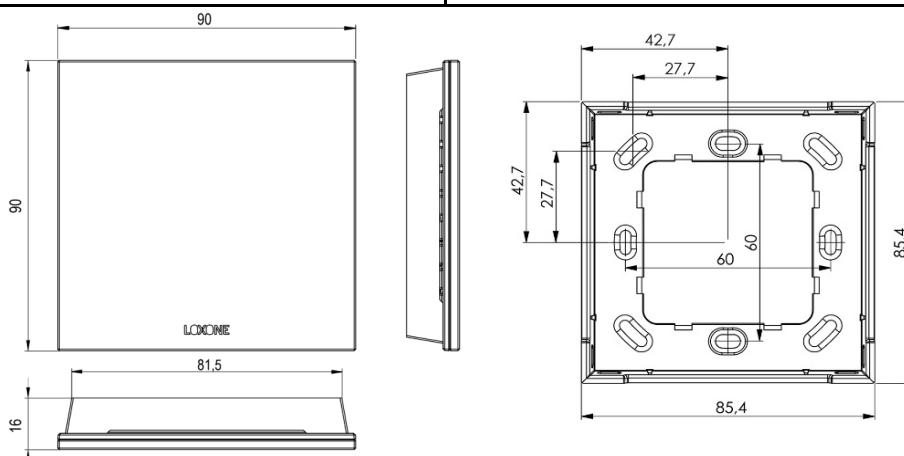

Packmaß	104x107x39mm / 4,09x4,21x1,54" (LxBxH)
---------	--

Zertifizierungen & Standards

Schutzart

IP30

Zertifizierungen

UL 62368-1

CSA C22.2#62368-1

RECOGNIZED
COMPONENT



Die Installation muss nach den einschlägigen Vorschriften durch eine Elektrofachkraft erfolgen.

Veröffentlicht von
Loxone Electronics GmbH

Smart Home 1
4154 Kollerschlag
Austria
Tel: +43 7287 7070-0
loxone.com